



Instruction Manual



465056 Electronic Gummed Tape Dispenser

Manufactured on Licence for : Springpack Limited
Address : Woodside Point, Williamson Road, Worcester,
WR5 1SG, United Kingdom.
Email : sales@springpack.co.uk
Website : www.springpack.co.uk

TABLE OF CONTENTS

Part I	Introduction -----	02
Part II	Unpacking and Inspecting -----	03
Part III	Safety Precautions -----	03
Part IV	Technical Data and Illustration -----	04
Part V	CNC Operation Interface Directions -----	06
Part VI	Operating Instructions -----	10
Part VII	Daily Maintenance -----	11
Part VIII	Troubleshooting -----	12
Part IX	After-Sales Service -----	13

Part I Introduction

The water activated tape dispenser, quickly applies the water and cuts tape to a fixed length, greatly improving the efficiency of the packing line. The machine also includes the following features:

- ◆ The world's first IntelliSense dispenser, equipped with intelligent computer numerical control interface and infrared sensor. It has the Manual Cutting Mode, and the IntelliSense & Auto Cutting Mode. Under the IntelliSense & Auto Cutting Mode, you can flexibly choose either Infrared Sensing Cutting or Automatic Cutting Mode.
- ◆ It is applicable to 100V~240V, not subject to international regional voltage restrictions.
- ◆ We can select 12 different lengths under Manual Cutting Mode, which can meet different sealing requirements and reduce the machine downtime.
- ◆ Equipped with movable pressure plate weight (fixed on the bottom of the equipment tape outlet side). According to the different thickness of the paper tape, the user can adjust the wet water uniformity by adding or reducing the weight. Both reinforced or non-reinforced kraft paper tape can be used.

In general, this cutting machine has the advantages of safety, efficiency and convenience. This operating manual solely provides necessary information about the machine operation, maintenance and repair of the WAT Dispenser, does not serve as a warranty of the product.

Disclaimer: in order to provide better assistance and guidance to our users, we reserve the rights to make necessary revisions and improvements to this operating manual without notifying users in advance.

Please read this Operating Manual carefully before using the equipment to ensure that the operator fully understands the function and the performance of the machine, and make sure to handle this dispenser correctly and safely.

If you want to know more about this product or need help, please contact Springpack directly.

Manufactured on license to: Springpack Limited

Telephone: 01905 751636

Website: www.springpack.co.uk

■ Part II Unpacking and Inspecting

An inspection of the water activated tape dispenser (WATD) is advised prior to its initial use. All items included are listed below for reference.

Model Number	WATD	Power Cords	Power Adapter	Water Tank	Water Box	Brush	weights	Tool Kit
465056	1	1		1	1	2	3	1

Note: The water tank, water box, brush and weights have been installed on the equipment before delivery

■ Part III Safety Precautions

In order to avoid personal injury caused by improper use of the equipment, please read and follow the safety instructions accordingly:

1. Please read this operation manual carefully before using the equipment to ensure that you have fully understood the performance of the equipment and understand the correct operation and maintenance methods.
2. If the machine is not installed and used properly, it may cause interference to radio communications (but fully complies with the relevant provisions of the FCC). If the device is used in a residential area, necessary measures may need to be taken to eliminate the interference of the device with radio communications.
3. Prior to removing a tape jam, you must ALWAYS to the power off and remove plug from outlet. When there is a need of professional cleaning for the equipment which might lead a breakdown or damage of the machine, please turn to a technician specifically.
4. If the equipment is to be moved, please ensure that the power is off, remove the water bottle, reservoir and the moistening brushes to prevent electric shock hazard due to the spill of water.
5. The surface of metal parts attached to the heater can retain heat even after use which could inflict severe skin burn if touched. Please do not touch it without taking any protective measures.
6. Using poor quality tape or replacement parts not recommended by the manufacturer, will increase the risk of unit failure and poor performance.
7. During the storage, transportation and handling of this product, please guard against squeezing, falling and impacting, so as to avoid deformation and damage of the units parts, which will affect the performance of the product.
8. Since the product contains sharp parts such as cutting knife, the product should be installed and kept away from children's reach to avoid personal injury.

Part IV Technical Data and Illustration

Technical Dimensional Data

MODEL	465056
Carton Dimension (mm)	580x345x335
Product Dimension (mm)	510x252x266
Gross Weight (kg)	12.1
Net Weight (kg)	11.0
Full Load Current (A)	1
Rated Power (W)	100
Electric Voltage (V)	100~240
Operating Frequency (Hz)	50~60
Battery Capacity (mA)	N/A
Tape Width (mm)	≤76
Diameter Roll (mm)	≤200
Cutting Speed (in/s)	34
Capacity of Water Bottle (L)	1.73
Brushes Piece/Set	2
Moistening Pressure Weight Piece/Set	3

Machine Drawing

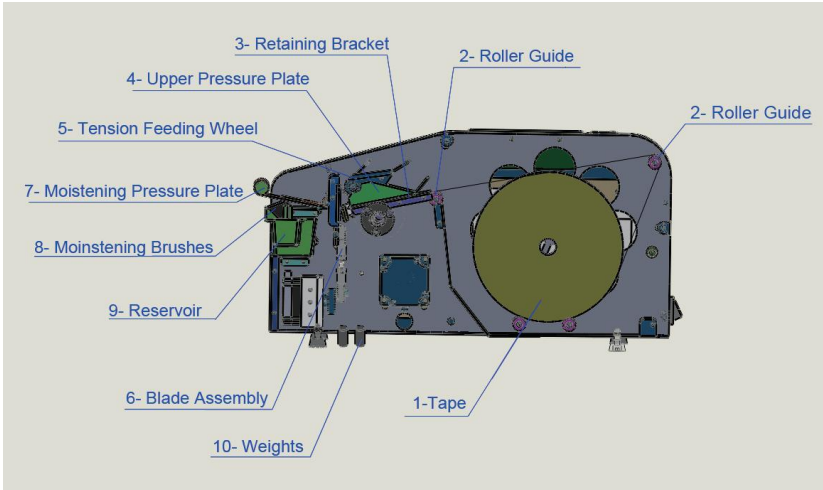

Electrical Schematic Diagram

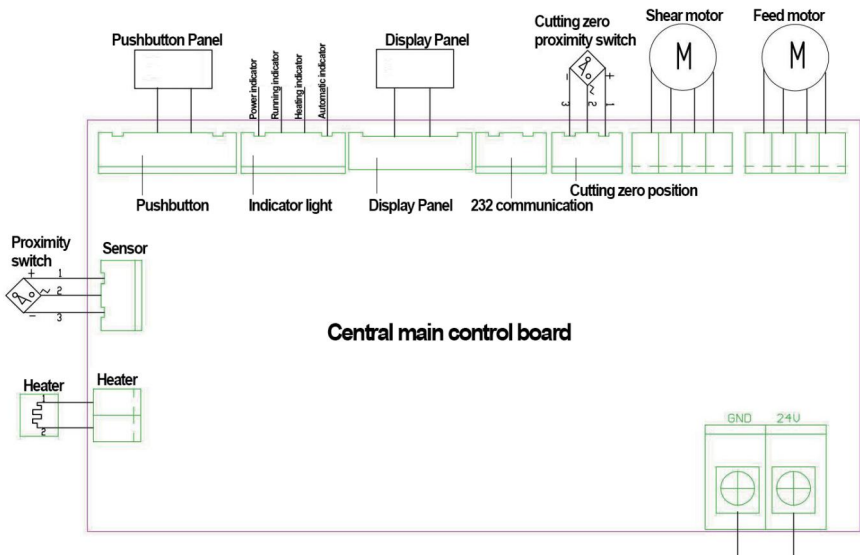

Part V CNC Operation Interface Directions

Interface 1: Startup Screen

When you turn on the power switch of the device, the CNC display screen will automatically enter the startup interface as shown in Figure 3, below. After the interface flashes for about 3 seconds, the device will automatically enter the "IntelliSense & Auto Cutting Mode" interface as shown in Figure 4.



Figure 3: Startup Screen

Interface 2: IntelliSense & Auto Cutting Mode

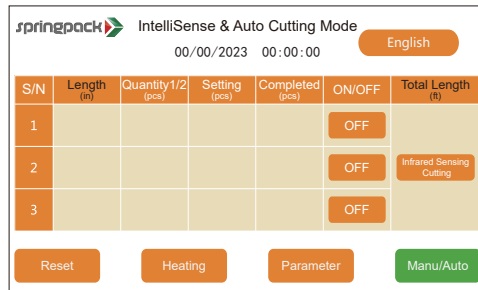

Figure 4: IntelliSense & Auto Cutting Mode

This interface is composed of a combined cutting task editing area and main function keys. The specific functions are displayed as follows:

Function keys

1. Reset: Initial cutting length calibration, reset button. Cutting precision can be controlled within $\pm 3\text{mm}$, which can effectively reduce the wastage of tape.

2. Heating: Start the heating function of the Reservoir. In low temperature. working environments, this function ensures effective water distribution across the tape.
3. Parameter: Press this function key to display the password input interface and enter the password (8888) to enter the "Parameter Setting" interface as shown in Figure 6.
4. Manual/Auto: Used for autonomous switching between automatic mode and manual mode.
5. Length: Set the cut length, the default unit is feet, which can be switched to centimetres by clicking "Length".

Combined Cutting Task Editing Area

1. S/N: The serial number of the work task instruction;
2. Length: Used to set the cutting length (unit: cm);
3. 1/2: Used to set the number of cut sheets corresponding to the specifications of each sealing cycle (1 or 2 pieces), which is mainly used in the "H" type box sealing scenarios.
4. Setting (pcs): Used to set the cutting quantity for the corresponding specification, the system default value is 9999. User can click the "Setting Pcs" value corresponding to the cutting task to modify the cutting quantity according to their needs.
5. Completed (pcs): Used to realize the number of pieces that have been cut. When the value of "Completed pcs" is equal to the value of "Set Pcs", the corresponding cutting task is completed and the device stops performing the task.
6. ON/OFF: It is used to set the "ON" or "OFF" status of the work task in the corresponding work task line.
7. Total Length(m): Display the cumulative length of cutting tape (unit: m). Long press the display area for 3 seconds to clear the data.
8. Induction cutting/ Auto cutting: Used to switch between "Induction cutting" and " Auto cutting" modes.

Interface 3: Manual Cutting Mode

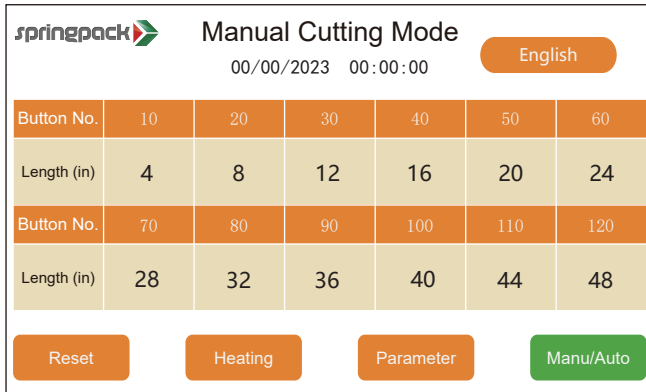

Figure 5: Manual Cutting Mode

This interface is the main interface for the manual cutting mode setting. It consists of an edit area and main function keys. The button numbers 10, 20, 30, ..., 120 on the interface are the factory default cutting lengths corresponding to the 12 buttons (unit: cm). Users can edit and set the cutting length corresponding to the 12 buttons according to actual needs. The description of each function key is the same as the previous introduction.

Interface 4: Parameter Setting

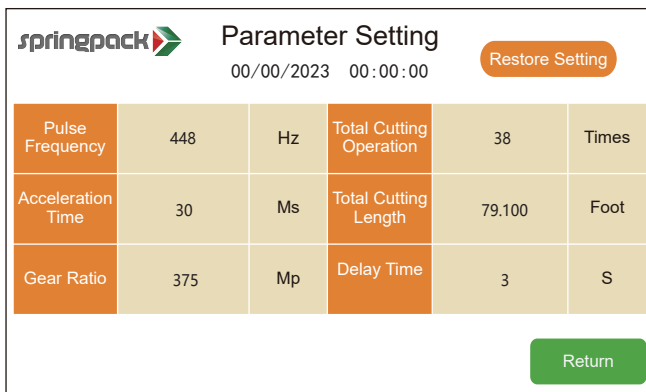

Figure 6: Parameter Setting Interface

The specific descriptions of the items displayed on this interface are as follows:

1. Pulse Frequency: the number of cycles produced across the gap in 1 second.
2. Acceleration Time: The time required for the stepping motor to reach a stable feeding speed from starting.
3. Gear Ratio: The technical ratio of gear mechanism to calibrate the cutting length error.
4. Total Cutting Operation: Displays the cumulative use times of the cutter. Long press the display area for 3 seconds to clear the data.
5. Total Cutting Length: Displays the cumulative length of the tape that has been cut, in meters. Long press the display area for 3 seconds to clear the data.
6. Delay Time: A span of time during which two same actions occurred.
7. Return: Press this key to return to the previous operation interface.
8. Restore Setting: Press this key, all the device parameters will be restored to the factory preset values.

Interface 5: Time Setting

When you enter interface 2 (Figure 4), interface 3 (Figure 5) and interface 4 (Figure 6), you will find a long string of numbers "2023/00/00 00:00:00" in "Date + Time" format below the name of the interface. Long press this area for 3~5 seconds to enter the date and time setting interface (Figure 7).

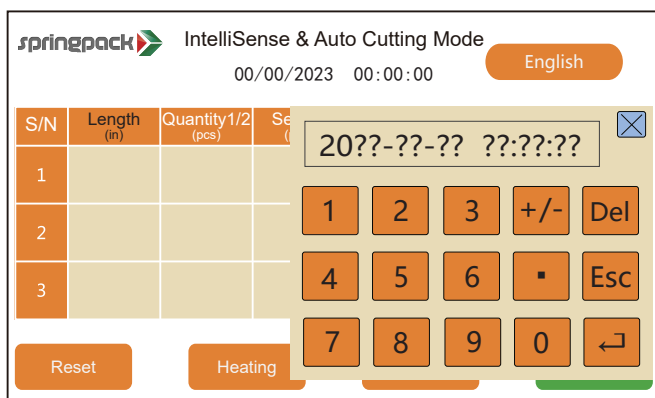

Figure 7: Time setting interface

■ Part VI Operating Instructions

Standard set up procedure:

Step 1: Add Water.

Remove the water bottle from the dispenser. Fill water up to approximately 80% full. Allow time for the water to settle. Install water bottle to the original position and add the remaining water.

Step 2: Install the Tape Roll.

Open the front and rear covers, pull the spring pressure roller and remove the pressure plate. Place the water-activated tape roll (gummed side down) on the two rollers. Pull the tape (front-end) backwards through the feed roller (gummed side down) and place under the pressure roller. Put the press plate back to its original position to complete the installation.

Step 3: Increase/Decrease the Weight on Pressure Plate.

The two brushes must be in completely wet and at the correct angle. If reinforced water activated paper tape is being used, the weight (fixed on the bottom plate at the outlet side, needs to be unscrewed) on press plate needs to be installed into the cylinder to ensure the tape wet evenly. If use non-reinforced water-activated tape, whether to install the weight or not is subject to the actual tape thickness, to ensure the best performance.

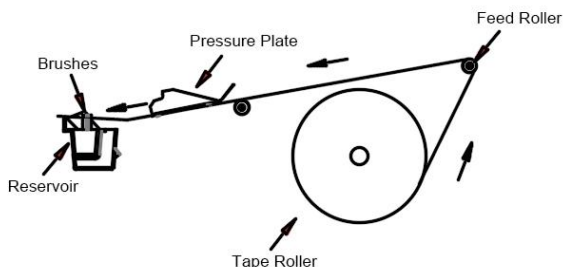

Figure 7: Introduction Diagram for Placing the Tape Roller

Step 4: Selection of Operation Mode and Operation Method

Plug in the device and turn on. Press the reset button, the machine will cut off the extra leading edge. In order to allow the device to be used across multiple tape applications, this dispenser is designed with IntelliSense & Auto Cutting Mode and Manual Cutting Mode. Users can choose according to actual needs.

“IntelliSense & Auto Cutting Mode” is designed for “I” type dispensing, “H” type dispensing and enhanced tape dispensing.

Specific operation method: Set the dispensing tape length and quantity and at S/N 1 and S/N 2 under IntelliSense & Auto Cutting Mode. Press the “ON” button. If you need enhanced type box sealing, you can set the dispensing tape length and quantity and at S/N 3. Press the “ON” button. If you need “I” type box sealing, you can set dispensing tape length and quantity and at any S/N.

In "induction cutting" mode, when you set the parameters of cutting tasks, press the "on/off" button and reach the tape outlet to get the cut tape for sealing. The "Auto Cutting" mode is a timed or delayed automatic cutting mode, users can set the interval time according to the actual sealing speed by clicking the number below the "Auto Cutting" function key (factory default setting: 3 seconds).

Manual Cutting Mode is suitable for application scenarios where multiple specifications are frequently switched. Specific operation method: Set the cutting length for the 12 buttons in the "Manual Cutting Mode" interface (factory setting value: 10, 20, 30...120) . And then press the corresponding button to conduct the tape cutting operation.

Part VII Daily Maintenance

We recommend the following daily maintenance schedule:

1. Check the water level of the water bottle frequently to avoid tape becoming dry, creating sealing issues.
2. Regularly clean the water brush, water bottle and reservoir with soapy water to avoid the accumulation of adhesive that affect the moistening effect of the tape.
3. Regularly use lubricating oil to lubricate the rotating parts of the equipment, such as the bearings and transmission belts, to avoid any running jams or blockages.
4. When the tape is jammed, carefully check and clean the channel to avoid tape jam again.

Part VIII Troubleshooting

During use, some minor faults may occur. In order not to affect your use, we recommend that you first check and resolve the faults according to the following guidance.

No.	Failure Description	Possible Reasons	Solution
1	External power is applied, but the device does not start normally.	(1) The device switch is not turned on. (2) The equipment plug is not properly inserted. (3) The electric outlets are not working.	(1) Turn on the power switch of the equipment. (2) Make sure the equipment is plugged in. (3) Turn on the electric outlets or insert the plug into a power socket.
2	No access to an external power source, the device can not be started properly.	(1) The device switch is not turned on. (2) The battery is low or exhausted.	(1) Turn on the power switch of the equipment. (2) Move the device to a place with external power supply for charging.
3	The device can be turned on normally, but the device did not execute the cutting command to cut the tape when it reached out to take the tape.	(1) The work order is not opened and is in the "OFF" state. (2) The position where the operator extends the hand is not within the sensing area of the infrared sensor of the equipment.	(1) Enter the task editing interface, click the task status button, and switch "OFF" to "ON". (2) Reach out your hand within the sensing area of the infrared sensor of the device.
4	The tape is not evenly wet and sealed nonstick.	(1) There is adhesive residue on the channel, water brush or outlet of the water bottle; (2) Insufficient water in the water bottle or reservoir; (3) The user has replaced the unqualified water brushes or placed the water brushes improperly; (4) Poor quality of the adhesive tape selected by the user; (5) Unevenly press the tape during the sealing process.	(1) Thoroughly clean the tape channel, water brushes or outlet of water bottle, and perform regular maintenance as required. (2) Add an appropriate amount of water to water bottle and the reservoir; (3) Purchase and use qualified water brushes, and place the brushes as required. (4) Purchase and use qualified tape; If use reinforced water activated tape, users need to install weights on pressure plate. (5) Press the surface of the tape evenly and make it evenly stressed during the sealing process.
5	The tape is often wrinkled, or jammed.	(1) Improper installation method of tape roll; (2) Adhesive residues accumulate on the channel or water brushes; (3) The tape selected by the user with poor quality; (4) The incision of the paper is not neat.	(1) Re-install the tape roll as required, especially check whether the pressure plate is placed correctly; (2) Check and thoroughly clean the channel or water brushes, and perform regular maintenance as required; (3) Purchase and use qualified tape; (4) Adjust the blade to the appropriate position.
<p>Note: If the problem is still not resolved through the above troubleshooting, please contact our professional after-sales service personnel.</p>			

■ Part IX After-Sales Service

The warranty period is one year from the date of purchase of the equipment. We provide the service of repairing and replacing defective parts of the machine free of charge during this period.

Repair/ part replacement services inside the warranty period will still be charged under the following situations:

1. The damage is caused by equipment handling, equipment installation and improper use
2. The damage is caused by natural disasters or other force majeure factors if user arranges transportation individually
3. The damages caused by individually dismantling or replacing any internal components of the equipment
4. The equipment is damaged due to the guidance of under qualified technicians or failure to follow this operation manual;
5. Quick-wear parts such as blade, water bottle, reservoir, brush, etc. are not covered by the warranty.

Appendix: Maintenance Service / Repair Record

Maintenance Service / Repair Record Card

User Information				
Customer Name		Purchase Date		
Model No.		Telephone Number		
Email Address		Postal code		
Address				
Dealer Information				
Dealer Name		Telephone Number		
Email Address		Postal Code		
Address				
Maintenance Records				
S/N	Warranty Reasons	Repair Content	Customer Acceptance	Maintenance Personnel
1				
2				
3				
4				
5				
6				
7				
8				
9				
10				
11				
12				